

Condensing Unit Technical Data Sheet

Model CMS34TB_N
Voltage 220-240V 50Hz ~1
Refrigerant R404A

APPLICATION

Application	High Back Pressure
Refrigerant	R404A
Evaporating Temp.	-15,0 °C to 10,0 °C
Expansion	Capillar/Valve
Comp. Cooling	Fan cooled
Max. ambient temp.	43,0 °C

COMPRESSOR

Displacement	34,42 cm ³
Diameter	42,86 mm
Stroke	23,85 mm
Oil type	ISO VG 46 ESTER
Oil charge	887 cm ³

MOTOR

Nominal Power	1 5/8 hp
Voltage/Frequency	220-240V 50Hz
Voltage range	198-255 V
Type	CSR
Phase number	1 PH
Locked Rotor Amps (LRA)	41,00 A
Max. Cont. Current (MCC)	17,50 A
Main W. resist. at 25°C	1,38 Ω
Start W. resist. at 25°C	4,58 Ω

NOMINAL PERFORMANCE

Cooling Capacity	4.788 W
COP	1,95 W/W
EER	1,67 kCal/Wh
Input Power	2.461 W
Current	12,07 A

ASHRAE

TEST CYCLE CONDITIONS

	HBP
Evaporating temp. (T _e)	7,2 °C
Condensing temp. (T _c)	55,0 °C
Liquid temp. (T _{liq.})	46,0 °C
Ambient temp. (T _{amb.})	35,0 °C
Suction temp. (T _{suction})	35,0 °C
Voltage/Frequency	220 V 50 Hz

CONDENSER AND FAN DATA

Condenser type	CU-AL
Condenser model	14T 4R
Fan blade (Ø mm / °)	300 / 27
Fan motor	85W 230V 50/60Hz

WIRING DIAGRAM

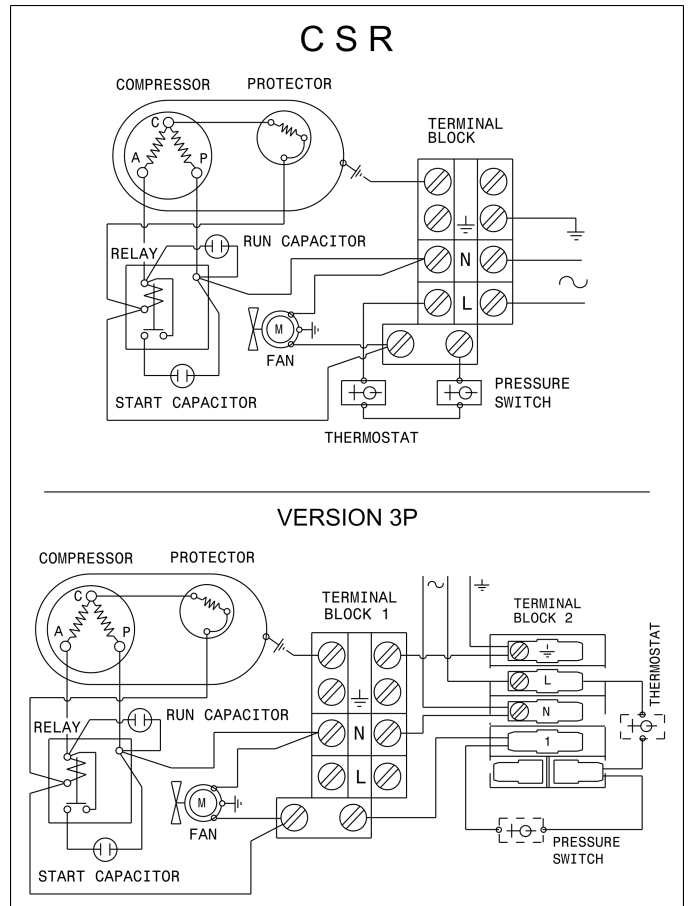

REFRIGERATION CAPACITY (W) Evaporating Temperature (°C)

Model	Motor	-25	-15	-5	5	7.2			10
						W	Winp	A	
CMS34TB_N	CSR	1369	2459	3524	4563	4788	2461	12.07	5073

ASHRAE HBP: Condensing temperature: 55°C, Liquid temperature: 46°C, Suction temperature: 35°C, Ambient temperature: 35°C

Condensing Unit Technical Data Sheet

VERSIONS

VERSION 1	VERSION 2	VERSION 3	VERSION 3P	VERSION 4
Tube	Service valve	Service valve and receiver	Service valve, receiver, pressure switch	Schrader valve on the service port
Suction tube internal diam.: 12,7 mm Discharge tube internal diam.: 8,0 mm Net Weight: 40,0 Kg	Suction valve: 5/8" Discharge valve: 3/8" Net Weight: 41,0 Kg	Receiver vol.: 2,4 l Suction valve: 5/8" Discharge valve: 3/8" Net Weight: 42,5 Kg	Receiver vol.: 2,4 l Suction valve: 5/8" Discharge valve: 3/8" Net Weight: 43,5 Kg	Suction tube internal diam.: 12,7 mm Discharge tube internal diam.: 8,0 mm Net Weight: 41,0 Kg

DIMENSIONS (Version 3 drawing)

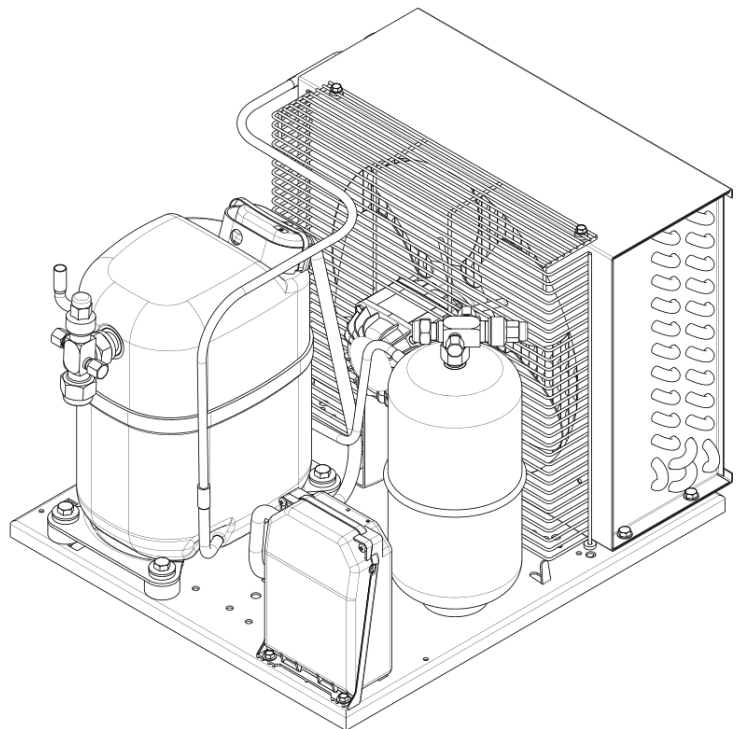
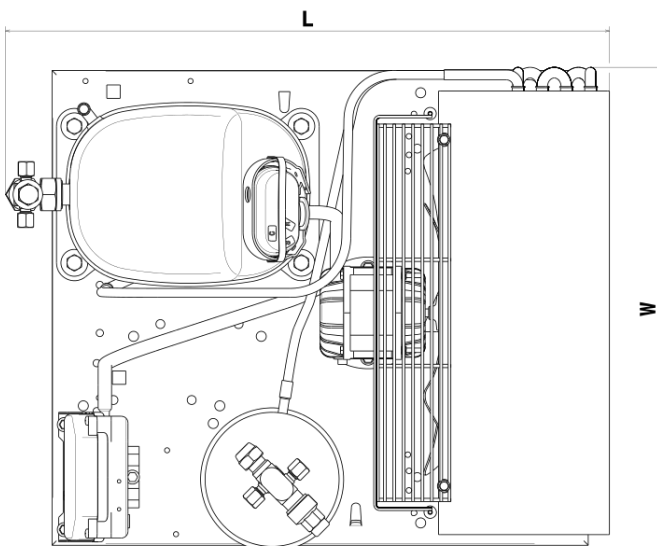
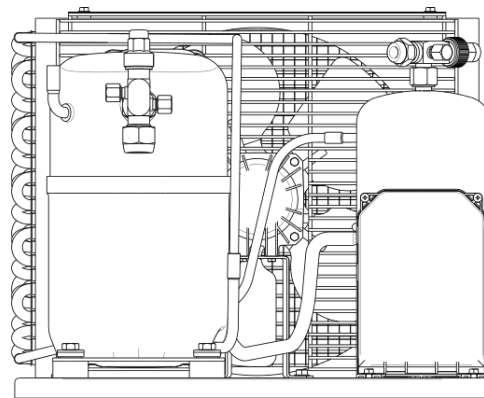
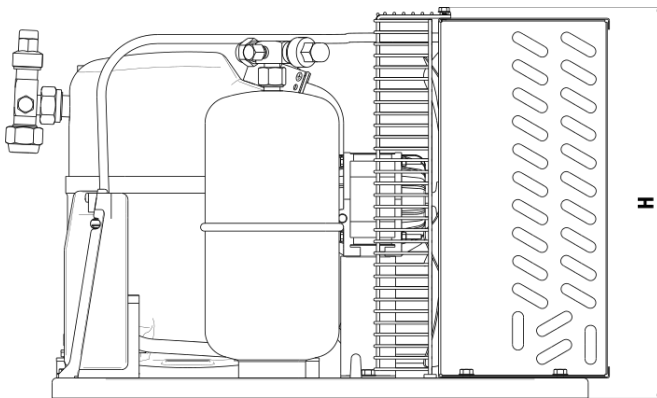

VERSION 1-4 (WxLxH) (mm)	VERSION 2 (WxLxH) (mm)	VERSION 3 (WxLxH) (mm)	VERSION 3P (WxLxH) (mm)
460x505x375	460x535x375	460x535x375	460x535x375