





# **XC460D**

**(v2.1)**

# INDEX

<b>1.</b>	<b>GENERAL WARNING</b>	<b>4</b>
1.1	 PLEASE READ BEFORE USING THIS MANUAL	4
1.2	 SAFETY PRECAUTIONS	4
<b>2.</b>	<b>GENERAL DESCRIPTION</b>	<b>4</b>
<b>3.</b>	<b>FIRST INSTALLATION</b>	<b>4</b>
3.1	HOW TO SET THE KIND OF GAS	5
3.2	HOW TO SET THE RANGE OF THE PRESSURE PROBES	5
3.3	HOW TO SET THE KIND OF DISPLAY: RELATIVE OR ABSOLUTE PRESSURE	6
<b>4.</b>	<b>USER INTERFACE</b>	<b>6</b>
4.1	DISPLAYING	6
4.2	KEYBOARD	6
4.3	ICONS	7
<b>5.</b>	<b>HOW TO SEE AND MODIFY THE SET POINT(S)</b>	<b>7</b>
5.1	HOW TO SEE THE SET POINT OF COMPRESSORS AND/OR FANS	7
5.2	HOW TO MODIFY THE SET POINT OF COMPRESSORS AND/OR FANS	7
<b>6.</b>	<b>PARAMETERS PROGRAMMING</b>	<b>8</b>
6.1	HOW TO ENTER THE "PR1" PARAMETER LIST	8
6.2	HOW TO ENTER IN PARAMETERS LIST "PR2"	8
6.3	HOW TO CHANGE PARAMETER VALUES	8
<b>7.</b>	<b>HOW TO DISABLED AN OUTPUT</b>	<b>9</b>
7.1	HOW TO DISABLED AN OUTPUT DURING A MAINTENANCE SESSION.	9
7.2	OUTPUT DISABLED SIGNALLING.	9
7.3	REGULATION WITH SOME OUTPUTS DISABLED.	9
<b>8.</b>	<b>RUNNING HOURS OF LOADS</b>	<b>9</b>
8.1	HOW TO DISPLAY THE RUNNING HOURS OF A LOAD.	9
8.2	HOW TO RESET THE RUNNING HOURS OF A LOAD.	9
<b>9.</b>	<b>ALARM MENU</b>	<b>9</b>
9.1	HOW TO SEE THE ALARMS	10
<b>10.</b>	<b>USE OF THE PROGRAMMING "HOT KEY "</b>	<b>10</b>
10.1	HOW TO PROGRAM A HOT KEY FROM THE INSTRUMENT (UPLOAD)	10
10.2	HOW TO PROGRAM AN INSTRUMENT USING A HOT KEY (DOWNLOAD)	10
<b>11.</b>	<b>KEYBOARD LOCKING</b>	<b>10</b>
11.1	HOW TO LOCK THE KEYBOARD	10
11.2	TO UNLOCK THE KEYBOARD	10

<b>12.</b>	<b>LIST OF PARAMETERS</b>	<b>11</b>
12.1	PLANT DIMENSIONING AND TYPE OF REGULATION.	11
12.2	PROBES CONFIGURATION	12
12.3	OTHERS INPUTS CONFIGURATION	13
12.4	DISPLAY AND MEASUREMENT UNIT	13
12.5	COMPRESSORS REGULATION	13
12.6	FANS REGULATION	14
12.7	ALARMS – COMPRESSOR SECTION	14
12.8	ALARMS – FANS SECTION	14
12.9	DYNAMIC SET POINT	15
12.10	ANALOG OUTPUT (OPTIONAL)	15
12.11	OTHER	15
<b>13.</b>	<b>TYPE OF REGULATION</b>	<b>15</b>
13.1	DEAD BAND – ONLY FOR COMPRESSORS	15
13.2	PROPORTIONAL BAND – FOR COMPRESSORS AND FANS	16
<b>14.</b>	<b>MOUNTING &amp; INSTALLATION</b>	<b>17</b>
<b>15.</b>	<b>ELECTRICAL CONNECTIONS</b>	<b>17</b>
15.1	PROBES CONNECTION	17
<b>16.</b>	<b>RS485 SERIAL LINK</b>	<b>17</b>
<b>17.</b>	<b>ALARM LIST</b>	<b>18</b>
17.1	TYPES OF ALARMS AND SIGNALLING MANAGED	18
17.2	ALARM MUTING	19
17.3	ALARM CONDITIONS – SUMMARY TABLE	20
<b>18.</b>	<b>TECHNICAL FEATURES</b>	<b>21</b>
<b>19.</b>	<b>WIRING CONNECTIONS</b>	<b>21</b>
<b>20.</b>	<b>PARAMETERS – DEFAULT VALUES</b>	<b>22</b>

## 1. GENERAL WARNING

### 1.1 PLEASE READ BEFORE USING THIS MANUAL

- This manual is part of the product and should be kept near the instrument for easy and quick reference.
- The instrument shall not be used for purposes different from those described hereunder. It cannot be used as a safety device.
- Check the application limits before proceeding.
- Dixell Srl reserves the right to change the composition of its products, even without notice, ensuring the same and unchanged functionality.

### 1.2 SAFETY PRECAUTIONS

- Check the supply voltage is correct before connecting the instrument.
- Do not expose to water or moisture: use the controller only within the operating limits avoiding sudden temperature changes with high atmospheric humidity to prevent formation of condensation
- Warning: disconnect all electrical connections before any kind of maintenance.
- The instrument must not be opened.
- In case of failure or faulty operation send the instrument back to the distributor or to "DIXELL S.r.l." (see address) with a detailed description of the fault.
- Consider the maximum current which can be applied to each relay (see Technical Data).
- Ensure that the wires for probes, loads and the power supply are separated and far enough from each other, without crossing or intertwining.
- Fit the probe where it is not accessible by the end user.
- In case of applications in industrial environments, the use of mains filters (our mod. FT1) in parallel with inductive loads could be useful.

## 2. GENERAL DESCRIPTION

The XC460D is designed to manage both compressors and fans in a condensing system such as a pack.

The compressors can be simple, multistage or with different capacities.

Control is by means of a neutral zone or proportional band and is based on the pressure or temperature sensed in the LP suction (compressors) and HP (condenser) circuits. A special algorithm balances the run hours of the compressors to distribute the work load uniformly.

The controllers can convert both LP and HP pressures and display them as temperatures.

The front panel offers complete information on the system's status by displaying the suction and condenser pressure (temperatures), the status of the loads, possible alarms or maintenance conditions.

Each load has its own alarm input that is able to stop it when activated. To guarantee the total system's safety, there are also two inputs for low and high pressure switches: when these are activated, the system is stopped.

By means of the HOT KEY the controller can be easily programmed at power on.

The controller can be connected to the XJ500, controlling and monitoring system, thanks to the serial TTL output, using the standard ModBus RTU protocol.

## 3. FIRST INSTALLATION

At first installation, it's necessary the following:

1. **Select the kind of gas.**
2. **Set the range of the pressure probes.**

In the following paragraph a short cut for the above operations.

Chapters 6 PARAMETERS PROGRAMMING and 12 will show in detail these operations.

### 3.1 HOW TO SET THE KIND OF GAS

The controller has memorised the relation between temperature and pressure for some gases.

The pre-set gas is: r404.

If another gas is used, act as in the following:

1. Enter the Programming mode by pressing the **Set** and **DOWN** key for 3s.
2. Select the "**Pr2**" parameter. Then enter the password 3 –2 1.
3. Select the **FtyP, kind of gas**, parameter.
4. Press the "**SET**" key: the value of the parameter will start blinking.
5. Use "**UP**" or "**DOWN**" to change the gas amount the following: . Select the gas among the following: **r22**= R22; **r404**=R404A; **507**=R507; **134**=134; **r717**= ammonia.
6. Press "**SET**" to store the new value and move to the following parameter.

**To exit:** Press **SET + UP** or wait 30s without pressing a key.

**NOTE:** the set value is stored even when the procedure is exited by waiting the time-out to expire.

### 3.2 HOW TO SET THE RANGE OF THE PRESSURE PROBES

If a instrument with the following part number is used: XC460D – xxxxF, it is pre-set to work with pressure probe with the following range:

Probe 1: -0.5 ÷11 bar (relative pressure);

Probe 2: 0÷30 bar (relative pressure)

If the probes you're using have a different range act as in the following:

To set the pressure range of the **Probe 1** use the parameter::

**PA04: Adjustment of read out corresponding to 4mA**

**PA20: Adjustment of read out corresponding to 20mA**

Practically these parameters has to be set with the start and end scale of the probe range.

**WARNING:** set a value correspondent to **absolute pressure**. If the transducer measures relative pressure increase the range of 1 bar.

**E.I. PP11** relative pressure transducer, range -0.5÷11.0 bar. PA04=0.50; PA20=12.00.

**PP30** relative pressure transducer, range: 0÷30bar. PA04=1.00; PA20=31.00.

#### How to do:

1. Enter the Programming mode by pressing the **Set** and **DOWN** key for 3s.
2. Select the "**Pr2**" parameter. Then enter the password 3 –2 1.
3. Select the **PA04, adjustment of read out corresponding to 4mA**, parameter.
4. Press the "**SET**" key: the value of the parameter will start blinking.
5. Set the lower value of the probe range (lower value +1 if the probe detects relative pressure).
6. Push the **SET** key to confirm the value. The **PA20: adjustment of read out corresponding to 20mA** parameter will be displayed.
7. Set the higher value of the range (higher value +1 if the probe detects relative pressure).
8. Push the **SET** key to confirm the value. Next parameter will be displayed.

Do the same things for the Probe 2, **FA04**, **FA20** parameters.

### 3.3 HOW TO SET THE KIND OF DISPLAY: RELATIVE OR ABSOLUTE PRESSURE

After setting the probe range by means of the PA04, PA20, FA04 and FA20 parameters, it's possible to select if the absolute or relative pressure has to be displayed.

The controller is pre-set for RELATIVE PRESSURE displaying.

If the **absolute pressure** has to be displayed, act as in the following:

9. Enter the Programming mode by pressing the **Set** and **DOWN** key for 3s.
10. Select the "Pr2" parameter. Then enter the password 3 -2 - 1.
1. Select by pushing the **UP** key the **rELP** parameter.
2. Push the **SET** to modify the value.
3. Set the **AbS** value and push the **SET** key to confirm it.

**To exit:** Press **SET + UP** or wait 30s without pressing a key.

## 4. USER INTERFACE

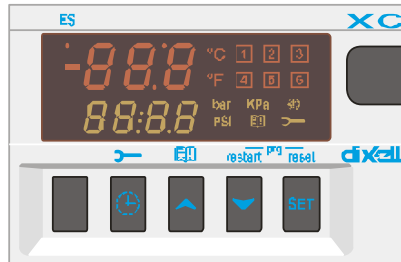

### 4.1 DISPLAYING

	UPPER DISPLAY	LOWER DISPLAY	ICONS
1 probe enabled	Temperature	Pressure	- Working loads - Measurement unit - Alarm or status Icons
2 probes enabled	Probe 1	Probe 2	- Working loads - Measurement unit - Alarm or status Icons

### 4.2 KEYBOARD

**SET** To see or modify the set point. in programming mode it selects a parameter or confirm an operation.

**Alarm menu:** By holding it pressed for **3s**, the current alarm is erased.

▲ **(UP) To enter the Alarm menu.**

**In programming mode:** it browses the parameter codes or increases the displayed value.

**With Hot key inserted:** it starts the Hot key programming procedure.

▼ **(DOWN) In programming mode:** it browses the parameter codes or decreases the displayed value.

**Manual restart of loads:** By holding it pressed for **3s**, it switches on again loads previous locked by a safety digital input alarm.

⌚ **CLOCK** To display the loads running hours.

By holding it pressed for 3s the **Maintaining menu** is entered.

## KEY COMBINATIONS

**^ + v** To lock and unlock the keyboard.

**SET + v** To enter the programming mode.

**SET + ^** To exit the programming mode.

## 4.3 ICONS

LED	FUNCTION	MEANING
°C	ON	Celsius degrees
°F	ON	Fahrenheit degrees
bar	ON	bar displaying
PSI	ON	PSI displaying
1	ON	Load 1 on
1	Flashing	Load 1 is waiting to start (1HZ). or digital input alarm for Load 1 (2Hz). o Load 1 in maintenance status (2Hz).
2	ON	Load 2 on
2	Flashing	Load 2 is waiting to start (1HZ). or digital input alarm for Load 2 (2Hz). o Load 2 in maintenance status (2Hz).
3	ON	Load 3 on
3	Flashing	Load 3 is waiting to start (1HZ). or digital input alarm for Load 3 (2Hz). o Load 3 in maintenance status (2Hz).
4	ON	Load 4 on
4	Flashing	Load 4 is waiting to start (1HZ). or digital input alarm for Load 4 (2Hz). o Load 4 in maintenance status (2Hz).
5	ON	Load 5 on
5	Flashing	Load 5 is waiting to start (1HZ). or digital input alarm for Load 5 (2Hz). o Load 5 in maintenance status (2Hz).
6	ON	Load 6 on
6	Flashing	Load 6 is waiting to start (1HZ). or digital input alarm for Load 6 (2Hz). o Load 6 in maintenance status (2Hz).
🔑	ON	The Maintenance menu has been entered
🔑	Flashing	One or more loads have been placed in maintenance status
🔔	ON	Alarm is happening
📄	ON	All the stored alarms have been seen.
📄	Flashing	A new alarm has happened

## 5. HOW TO SEE AND MODIFY THE SET POINT(S)

### 5.1 HOW TO SEE THE SET POINT OF COMPRESSORS AND/OR FANS

If the controller is managing both compressors and fans, both the set points are displayed in sequence, otherwise only the set point of the enabled section will be displayed.

 1) Push and release the **SET** key;

2) The Lower display will show the “**SEtC**” label, will the Upper display will show its value.

3) To see the fan set point push again the **SET** key.

4) The Lower display will show the “**SEtF**” label, will the Upper display will show the fan set point.

**To exit:** push the **SET** key or wait for 30 without pressing any keys.

### 5.2 HOW TO MODIFY THE SET POINT OF COMPRESSORS AND/OR FANS

**WARNING:** before setting the target set points for the first time, check and, if necessary, modify the type of freon (par. FtyP) and the default unit of measurement (par. dEU) for compressors and fans

## PROCEDURE

1. Set the kind of freon by means of the FtyP parameter (see 3.1 HOW TO SET THE KIND OF GAS)
2. Set the measurement unit (dEU par.).
3. Check and if necessary modify the set point limits (LSE and HSE par.).



1. Push the **SET** key for more than 2 seconds;
2. The Lower display will show the "**SEtC**" label, will the Upper display will show its value flashing.
3. To change the Set value push the **▲** or **▼** within 30s.
4. To memorise the new value and pass to the fan set point push the **SET** key.
5. The Lower display will show the "**SEtF**" label, will the Upper display will show the fan set point flashing.
6. To change its value push the **▲** or **▼** within 30s.

**To exit:** push the **SET** key or wait for 30 without pressing any keys.

## 6. PARAMETERS PROGRAMMING

### 6.1 HOW TO ENTER THE "PR1" PARAMETER LIST



To enter the "Pr1" parameter list, user accessible, operate as follows:

1. Hold pressed the **SET** and **DOWN** key for 3s.
2. The controller displays the name of the parameter in the Lower display, its value on the Upper display.
3. Press the "**SET**" key: the value of the parameter will start blinking.
4. Use "**UP**" or "**DOWN**" to change the value.
5. Press "**SET**" to store the new value and move to the following parameter.

**To exit:** Press **SET + UP** or wait 30s without pressing a key.

**NOTE:** the set value is stored even when the procedure is exited by waiting the time-out to expire.

### 6.2 HOW TO ENTER IN PARAMETERS LIST "PR2"

The "Pr2" parameter list is protected by a security code (Password).

**SECURITY CODE is 321**

To access parameters in "Pr2":

1. Enter the "Pr1" level.
2. Select "Pr2" parameter and press the "**SET**" key.
3. The flashing value "0 --" is displayed.
4. Use **o** or **n** to input the security code and confirm the figure by pressing "**SET**" key.
5. Repeat operations 2 and 3 for the other digits.

**NOTE:** each parameter in "Pr2" can be removed or put into "Pr1" (user level) by pressing "**SET**" + **▼**. When a parameter is present also in "Pr1" decimal point of the lower display is on.

### 6.3 HOW TO CHANGE PARAMETER VALUES

1. Enter the Programming mode.
2. Select the required parameter with **▲** or **▼**.
3. Press the "**SET**" key the value start blinking.
4. Use **o** or **n** to change its value.
5. Press "**SET**" to store the new value and move to the following parameter.

**To exit:** Press **SET + UP** or wait 15s without pressing a key.

**NOTE:** the new programming is stored even when the procedure is exited by waiting the time-out.



## 7. HOW TO DISABLED AN OUTPUT

To disabled an output during a maintenance session means to exclude the output from the regulation.

### 7.1 HOW TO DISABLED AN OUTPUT DURING A MAINTENANCE SESSION.



1. Push the **CLOCK** key for 3s.

The LED's of the first output is switched on, the Lower display shows the "**StA**" label, while the Upper display shows the "**On**" label if the first output is enabled, or the "**oFF**" label if the output is disabled for a maintenance section. With compressor with more steps all the LED's linked to the compressor and the valves are switched on.

2. Select the output by pressing the **UP** or **DOWN** key.
3. **To modify the status of the output:** push the **SET** key, the status of the output starts flashing, then push the UP or DOWN to pass from "**On**" to "**OFF**" and viceversa.
4. Push the **SET** key to confirm the status and pass to the next output..

**To exit:** push the **CLOCK** key or wait 30 sec

### 7.2 OUTPUT DISABLED SIGNALLING.

If an output is disabled its led blinks (2 Hz)

### 7.3 REGULATION WITH SOME OUTPUTS DISABLED.

If some outputs are disabled they don't take part to the regulation, so the regulation goes on with the other outputs.

## 8. RUNNING HOURS OF LOADS

### 8.1 HOW TO DISPLAY THE RUNNING HOURS OF A LOAD.

The controller memorises the running hours of each load.



To see how long a load has been working follow this procedure:



1. Press and release the "CLOCK" key.
2. The led of the first output is switched on, the Upper Display shows the "**HUR**" label, while the Lower Display shows the shows the running hours of the first output.
3. To see the running hours of the following load press the UP key.

**To exit:** push the **CLOCK** key or wait 30 sec

### 8.2 HOW TO RESET THE RUNNING HOURS OF A LOAD.

1. Display the running hour according to the above procedure.
2. Select the load by pressing the UP key.
3. Push the **SET** key (immediately on the lower display the **rSt** label is displayed).
4. Hold pushed the key for some seconds till the "**rSt**" label starts flashing and the lower display shows zero.

**To exit:** push the **CLOCK** key or wait 30 sec

**NOTE:** if the **SET** key is released within 2s, the controller reverts to display the running hours of the selected loads..

## 9. ALARM MENU

The controller memorises the last 20 alarms happened, together with their duration..

To see the alarm codes see par. **17 ALARM LIST**.

## 9.1 HOW TO SEE THE ALARMS

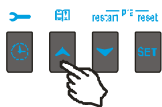

1. Push the **▲** key.
2. The last alarm happened is showed on the Upper display, while the lower display shows its number.
3. Push again the **▲** key and the other alarm are displayed starting from the most recent.
4. To see the alarm **duration** and push the **SET** key.
5. By pushing again the **▲** or **SET** key the next alarm is displayed.

### Alarms erasing.

1. Enter the Alarm Menu.
2. To erase the displayed alarm push the **"SET"** key till the **"rSt"** label will be displayed in the Lower Display,
3. **NOTE** the running alarms cannot be erased..
4. To erase the whole Alarm Menu, hold pressed the **"SET"** key for 10s.

## 10. USE OF THE PROGRAMMING "HOT KEY "

### 10.1 HOW TO PROGRAM A HOT KEY FROM THE INSTRUMENT (UPLOAD)

1. Program one controller with the front keypad.
2. When the controller is **ON**, insert the **"Hot key"** and push **▲** key; the **"uPL"** message appears followed a by flashing **"End"**
3. Push **"SET"** key and the **End** will stop flashing.
4. Turn OFF the instrument remove the **"Hot Key"**, then turn it ON again.

**NOTE:** the **"Err"** message is displayed for failed programming. In this case push again **▲** key if you want to restart the upload again or remove the **"Hot key"** to abort the operation.

### 10.2 HOW TO PROGRAM AN INSTRUMENT USING A HOT KEY (DOWNLOAD)

1. Turn OFF the instrument.
2. Insert a **programmed "Hot Key"** into the **5 PIN receptacle** and then turn the Controller ON.
3. Automatically the parameter list of the **"Hot Key"** is downloaded into the Controller memory, the **"doL"** message is blinking followed a by flashing **"End"**.
4. After 10 seconds the instrument will restart working with the new parameters.
5. Remove the **"Hot Key"**..

**NOTE** the message **"Err"** is displayed for failed programming. In this case turn the unit off and then on if you want to restart the download again or remove the **"Hot key"** to abort the operation.

The unit can **UPLOAD** or **DOWNLOAD** the parameter list from its own E2 internal memory to the **"Hot Key"** and vice-versa.

## 11. KEYBOARD LOCKING

### 11.1 HOW TO LOCK THE KEYBOARD

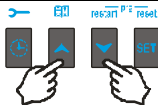

1. Keep the **▲** and **▼** keys pressed together for more than 3 s the **o** and **n** keys.
2. The **"POF"** message will be displayed and the keyboard is locked. At this point it is only possible to view the set point or enter the HACCP menu.

### 11.2 TO UNLOCK THE KEYBOARD

Keep the **▲** and **▼** keys pressed together for more than 3s till the **"POn"** flashing message appears.

## 12. LIST OF PARAMETERS

### 12.1 PLANT DIMENSIONING AND TYPE OF REGULATION.

**oA1, oA2, oA3, oA4, oA5, oA6 Outputs 1- 6 configuration:** by means of these parameters the plant can be dimensioned according to the number and type of compressors and/or fans and the number of steps for each one.

Each relay according to the configuration of the oA(i) parameter can work as:

- **Compressor:** oAi = cPr,
- **Step:** oAi = StP
- **Fan:** oAi = FAn
- **Alarm:** oAi = ALr
- **Not used:** oAi = nu

**NOTE:** also the "Lin" value is present. This value **must not** be used..

According to the oA1÷oA6 configuration, 3 kinds of plant can be defined:

**Rack with compressors only:** all the oAi different from FAn

**Rack with fans only:** all the oAi different from CPr of StP

**Rack with compressors and fans:** both FAn and CPr are used for oAi.

#### COMPRESSORS CONFIGURATION

The regulation is **always** performed by the P1 Probe.

With **step compressors** the output of compressor has to be set before the output of the step.

**ES.** Compressor with 3 steps: **oA1 = cPr, oA2= StP, oA2 = StP.**

**If an oAi set as step without any previous oAi set as cPr the configuration alarm "CStP" will be activated.**

If compressor with different capacities are used (**CtyP=dPo**), all the oAi must be configured as **cPr** (compressor) otherwise the **configuration alarm "CStP" will be activated.**

#### RACK WITH FANS ONLY

If none compressor is present, the regulation of the fans is performed through the P1 probe.

If are present both compressors and fans (Cpr+Fan) the regulation of the fans is performed through the P2 probe.

**In this case if the probe P2 is set not present (par. P2P=no) configuration alarm "AoP2" will be activated..**

#### PLANT CONFIGURATION EXEMPLA:

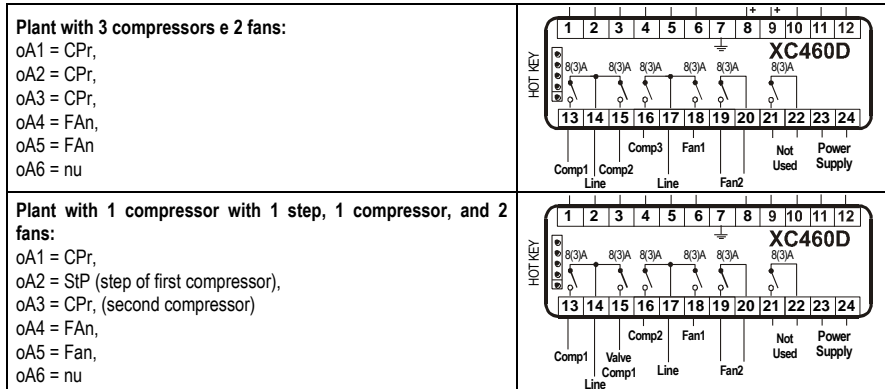

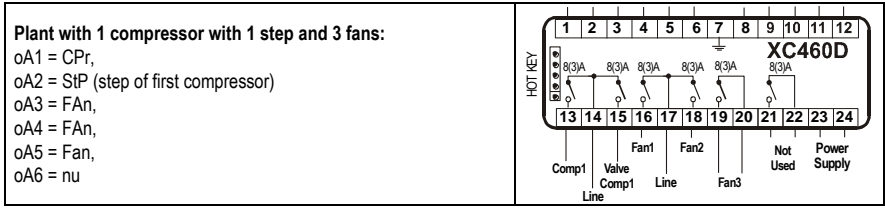

- CtYP Compressor type:** it sets if compressors have the same power (homogeneous) or not.  
**dPo = compressor with different capacities:** in this case the regulation is neutral zone.  
**SPo = homogeneous:** the regulation can be neutral zone or proportional band.  
**Scr = don't set it**
- StP valve outputs polarity:** polarity of the outputs for capacity valves. It determines the state of the relays associated with the capacity valves (only for homogeneous and stepped-capacity compressors):  
**oP**=valve enabled with open contact;  
**cL**= valve enabled with closed contact.
- PC1 ..PC6 Power of compressor 1...6:** for setting the power of single compressors. Available only if CtYP=dPo. The power is identified by a value (range 1÷255) proportional to the capacity of single compressor.  
**E.I.** 3 compressors with following capacity: 10, 20, 40 HP. The parameters have to be set in these way: PC1=10, PC2=20, PC3=40.
- FtyP Freon Type:** set the kind of freon used in the plant  
**r22 = R22; r404= R404A ; 507= R507; 134=134; r717=r717 (ammonia)**
- rTy Type of regulation (see par. 13 TYPE OF REGULATION)**  
**db = neutral zone, Pb = proportional band.**
- CH Type of action: CL = cooling (direct action); Ht = heating (inverse action).**  
**with dead band regulation:**
  - if pressure/temperature is lower than regulation band, resources are activated.
  - if pressure/temperature is bigger than regulation band, resources are deactivated.**with proportional band regulation:**
  - if pressure/temperature decreases crossing various bands, the resources are activated
  - if pressure/temperature increases crossing various bands, the resources are deactivated
- Sty Activation type of sequence for compressors**  
**YES = rotation:** this algorithm distributes the working time between the various loads to ensure even run times.  
**no = fixed sequence:** the compressors are enabled and disabled in fixed sequence: first, second etc.
- rot Activation type of sequence for fans**  
**YES = rotation:** this algorithm distributes the working time between the various loads to ensure even run times.  
**no = fixed sequence:** the compressors are enabled and disabled in fixed sequence: first, second etc.

**12.2 PROBES CONFIGURATION**

Probes can be used in different ways according to plant features, as described in the following table:

Kind of plant	Probe 1 - NTC/PTC: term. 11-12 // - 4-20mA: term. 9(+), 11 (in)	Probe 2 - NTC/PTC: term. 10-12 // - 4-20mA : term.9 (+), 10 (in)
Compressors and fans	Compressor regulation	Fan regulation
Compressors only	Compressor regulation	<ul style="list-style-type: none"> <li>- Absent (P2P=no) or</li> <li>- For Dynamic set point or</li> <li>- For 4-20mA output (if present)</li> </ul>
Fans only	Fans regulation	<ul style="list-style-type: none"> <li>- Absent (P2P=no) or</li> <li>- For Dynamic set point or</li> <li>- For 4-20mA output (if present)</li> </ul>

### 12.2.1 Probe 1 configuration

**Pbc** Probe 1 setting. Cur = 4 ÷ 20 mA probe; ntc = NTC probe, Ptc = NTC probe.

**PA04** Adjustment of read out for the Probe 1 (used only if Pbc=Cur). corresponding to 4mA input signal, given by the suction probe (0 ÷ 31 bar or 0÷450 PSI or 0÷3100KPA)

**Warning:** set a value correspondent to absolute pressure. If the transducer measures relative pressure increase the range of 1 bar.

See also par. 3.2 HOW TO SET THE RANGE OF THE PRESSURE PROBES

E.I. PP11 relative pressure transducer, range -0.5÷12.0 bar. PA04=0.5 (-0.5+1); PA20=12.0 (11+1).

PP30 relative pressure transducer, range: 0÷30bar. PA04=1; PA20=31.

**PA20** Adjustment of read out for the Probe 1 corresponding to 20mA input signal, given by the suction probe (0 ÷ 31.0 bar or 0÷450 PSI or 0÷3100KPA) **SEE THE WARNING FOR PA04.**

**CAL** Probe 1 calibration (-12.0÷12.0 bar; -12.0÷12.0°C or -20÷20 PSI/°F)

### 12.2.2 Probe 2 configuration

**P2P** Probe 2 presence: no = probe 2 absent; yes = probe 2 present.

**Pbc2** Probe 2 setting. Cur = 4 ÷ 20 mA probe; ntc = NTC probe, Ptc = NTC probe.

**FA04** Adjustment of read out for the Probe 2 (used only if Pbc2=Cur). corresponding to 4mA input signal, given by the suction probe (0 ÷ 31 bar or 0÷450 PSI or 0÷3100KPA)

**Warning:** set a value correspondent to absolute pressure. If the transducer measures relative pressure increase the range of 1 bar.

See also par. 3.2 HOW TO SET THE RANGE OF THE PRESSURE PROBES

E.I. PP11 relative pressure transducer, range -0.5÷12.0 bar. PA04=0.5 (-0.5+1); PA20=12.0 (11+1).

PP30 relative pressure transducer, range: 0÷30bar. PA04=1; PA20=31.

**FA20** Adjustment of read out for the Probe 2 corresponding to 20mA input signal, given by the suction probe (0 ÷ 31.0 bar or 0÷450 PSI or 0÷3100KPA) **SEE THE WARNING FOR PA04.**

**FCAL:** Probe 2 calibration (-12.0÷12.0 bar; -12.0÷12.0°C or -20÷20 PSI/°F)

## 12.3 OTHERS INPUTS CONFIGURATION

**ALIP** Alarm input for compressors and fans polarity

oP: the digital input is activated by opening the contact;

CL: the digital input is activated by closing the contact.

**ALMr** Manual reset of alarms for compressors and fans.

no = automatic recover of alarm: regulation restart when the correspondent digital input is disabled

yes = manual recover for the alarms of compressors and fans See also par. 0

EA1÷EA6: Compressors and fans safeties alarm.

## 12.4 DISPLAY AND MEASUREMENT UNIT

**dEU:** Default measurement unit for displaying (bar=bar; °C=°C, PSI=PSI; °F=°F)

**NOTE1:** The dEU parameter sets the measurement unit also for the set point and the following parameters: CAL, FCAL, Pbd, ESC, LSE, HSE, Pb, ESF, LSF, HSF, LAL, HA, LAF, HAF.

**NOTE2:** The controller automatically converts values of set point and following parameters CAL, FCAL, Pbd, ESC, LSE, HSE, Pb, ESF, LSF, HSF, LAL, HA, LAF, HAF in the measurement unit set in dEU parameter. In any case after modifying this parameter it's better check and modify if necessary the set point and the above parameters.

**rES** Resolution for °C and bar (in = integer; dE= decimal point)

**dSP2** Default visualisation of lower display: nu= not used; P1= probe one; P2= probe two; SET1; SET2

**dEU2** Lower display probe format: PrS= Pressure; IPr= temperature

**rELP** Pressure displaying: AbS = absolute pressure; rEL = relative pressure.

**NOTE:** In this case the pressure displayed, the set point and the following parameters LSE HSE, LSF and HSF are automatically decreased by 1.0 bar or 14 PSI

## 12.5 COMPRESSORS REGULATION

**Pbd:** Proportional band or neutral zone width (0.10÷5.00bar/0.5÷30°C or 1÷80PSI/1÷50°F)

The band (or zone) is symmetrical compared to the target set point, with extremes: set+Pbd/2 ... set-Pbd/2. The measurement unit depends on the dEU par.

- onon:** **Minimum time between 2 following switching ON of the same compressor** (0÷255 min).
- oFon:** **Minimum time between the switching off of a compressor and the following switching on.** (0÷255min). **Note:** usually onon is greater than oFon.
- don** **Time delay between the insertion of two different compressors** (0÷99.5min; res. 10s).
- doF** **Time delay between switching off of two different compressors** (0÷99.5 min; res. 10s)
- donF** **Minimum time a stage stays switched ON** (0÷99.5 min; res. 10s)
- Maon** **Maximum time for compressor ON**
- FdLy** **“don” delay enabled also for the first call.** If enabled, the triggering of the step is delayed for a “don” value, respect to the call. (**no** = “don” not enabled; **yES**=“don” enabled)
- FdLF** **“doF” delay enabled also for the first switching off.** It enables the “doF” delay between the request of a release and the actual switching off.  
(**no** = “doF” not enabled; **yES**=“doF” enabled)
- odo** **Regulation delay on start-up:** (0÷255s) on switching ON the instrument starts working after the time delay imposed in this parameter.
- LSE** **Minimum set point for compressors:** The measurement unit depends on dEU parameter. It sets the minimum value that can be used for the set point, to prevent the end user from setting incorrect values.
- HSE** **Maximum set point for compressors:** The measurement unit depends on dEU parameter. It sets the maximum acceptable value for set point.

## 12.6 FANS REGULATION

- Pb** **Proportional band zone width** (00.10÷5.00bar/0.5÷30°C or 1÷80PSI/1÷50°F).  
**Set the dEU par. and the target set point for fans before setting this parameter.** The band is symmetrical compared to the target set point, with extremes: set+Pb/2 ... set-Pb/2. The measurement unit depends on the dEU par.
- Fon** **Time delay between the insertion of two different fans** (0÷255sec).
- FoF** **Time delay between switching off of two different compressors** (0÷255 sec)
- LSF** **Minimum set point for fans:** The measurement unit depends on dEU parameter. It sets the minimum value that can be used for the set point, to prevent the end user from setting incorrect values
- HSF** **Set Maximum set point for fans:** The measurement unit depends on dEU parameter. It sets the maximum acceptable value for set point.

## 12.7 ALARMS – COMPRESSOR SECTION

- PAo:** **Alarm probe exclusion at power on.** it is the period starting from instrument switch on, before an alarm probe is signalled. (0÷255 min). During this time if the pressure is out of range all the compressor are switched on.
- LAL:** **Low pressure (temperature) alarm – compressor section:** The measurement unit depends on dEU parameter. It's always subtracted to the set point. When the value **SET-LAL** is reached the A03C alarm is enabled, (possibly after the **tAo** delay time).
- HAL:** **High pressure (temperature) alarm– compressor section:** The measurement unit depends on dEU parameter. It's always added to the set point. When the value **SET+HAL** is reached the A04C alarm is enabled, (possibly after the **tAo** delay time).
- tAo:** **Low and High pressure (temperature) alarms delay– compressor section:** (0÷255 min) time interval between the detection of a pressure (temperature) alarm condition and alarm signalling.
- Ser:** **Service request:** (1÷9990 hours, res. 10h) number of running hours after that the “A14” maintenance call is generated.
- SPr:** **number of steps engaged with faulty probe.** (0÷#compr).
- PoPr:** **capacity engaged with faulty probe** (0÷100%) It's used only if CityP=dPo.

## 12.8 ALARMS – FANS SECTION

- LAF:** **Low pressure alarm – fans section:** The measurement unit depends on the dEU parameter. It's always referred to fan set point When the value **SETF-LAF** is reached the LA2 alarm is enabled, (possibly after the **AFd** delay time).
- HAF:** **High pressure alarm – fans section:** The measurement unit depends on the dEU parameter. It's always referred to the set point. When the value **SETF+HAF** is reached the HA2 alarm is enabled, (possibly after the **AFd** delay time).

- AFd:** Low and High pressure alarms delay – fans section: (0÷255 min) time interval between the detection of a pressure alarm condition in the fans section and alarm signalling.
- FPr** Number of fans engaged with faulty probe. (0÷#fans).

## 12.9 DYNAMIC SET POINT

- dSEP** Dynamic set point enabling (no = dynamic set point disabled; **yES** = dynamic set point enabled)  
**WARNING** the dynamic set point requires a dedicated probe, so it's necessary that all the loads are the same kind. (El. fans).
- dSES** External temperature set point to start dynamic regulation (-50.0 ÷ 150.0 °C)
- dSEb** External band width for dynamic set point (-50.0 ÷ 50.0°C)
- dSEd** Set point differential for dynamic set point: -20.0÷20.0bar; -50.0÷50.0°C

## 12.10 ANALOG OUTPUT (OPTIONAL)

- AOP** Reference probe for analog output: nP = no probe; P1= Probe 1; P2= Probe 2
- LAO** Start of scale for analog output: it's temperature (pressure) detected by the probe which is associated the 4mA value: (0.0÷51.0bar; -50.0÷150.0°C)
- UAO** End of scale for analog output: it's temperature (pressure) detected by the probe which is associated the 20mA value: (0.0÷51.0bar; -50.0÷150.0°C)
- AOM** Minimum value for analog output (4 ÷ 20mA)
- SAO** Percentage of analog output in case of probe failure: (0 ÷ 100%)

## 12.11 OTHER

- tbA** Alarm relay silencing: by pushing one of the keypad buttons. no= alarm relay stays on; **yES**= alarm relay is switched off by pushing any keys.
- OAP** Alarm relay output polarity: cL=closed when activated; oP= opened when activated
- oFF** Switching ON/OFF enabling from keyboard: (no = disabled; **yES**= enabled) It permits the switching ON/OFF of the instrument by pressing the SET key for more than 4s.
- Ad1:** Compressors address (1–247) It is used in monitoring system.
- Ad2:** Fans address (1–247) It is used in monitoring system.
- Ptb** Parameter table code: readable only.
- rEL** Software release for internal use.
- Pr2** Access to the protected parameter list (read only).

## 13. TYPE OF REGULATION

### 13.1 DEAD BAND – ONLY FOR COMPRESSORS

This kind of regulation is available only for compressors. The neutral zone (Pbd) is symmetrical compared to the target set point, with extremes: set+Pbd/2 ... set-Pbd/2. If the pressure (temperature) is inside this zone the controller maintains the same number of loads switched on and off, without changing anything.

When the pressure (temperature) go out from the zone, regulation starts. If the pressure is greater than SET+Pbd/2, the loads are switching on with timing given by parameters: don and doF.

A load is turned on only if the his safety times **onon**, **oFon**, **donF** are over.

Regulation stops when the pressure (temperature) come back into the neutral zone.

In the following a simplify exemplum that explains the regulation in neutral zone for compressor homogeneous with 1 step for each compressors. The safety times onon, oFon and donF are not considered. In the real regulation the a load is entered or turned off only if these times are over.

**Ex. Dead band control, compressors with same capacities, 1 step for each compressor.**

**In this example:**

**oA1 = cPr; oA2 = cPr; oA3 = cPr; oA4 = nu; oA5 = nu; oA6 = nu**

**CtyP = SPo** homogeneous compressors;

**rty = db** dead band regulation

**Sty = yES** rotation

**FdLy = no** "don" delay not enabled at first calling after an equilibrium condition.

**dLF = no** "doF" delay not enabled at first calling after an equilibrium condition.





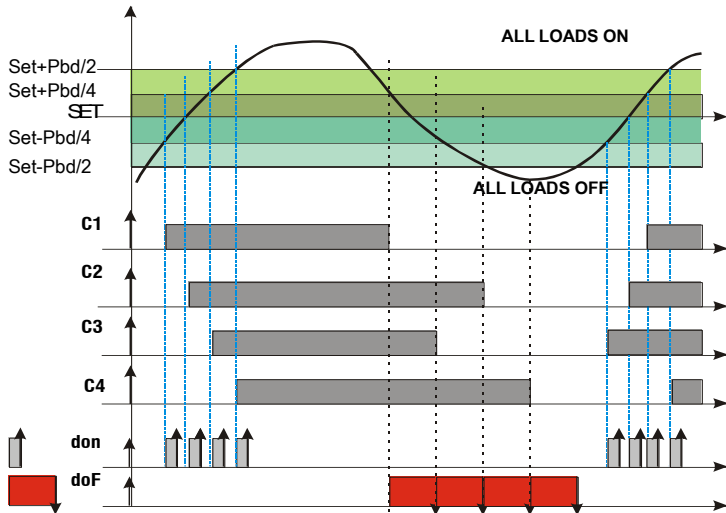

This draw highlights the doF time: the loads are in fact turned off only when the doF time is over.

## 14. MOUNTING & INSTALLATION

The XC460D shall be mounted on an omega DIN rail. The temperature range allowed for correct operation is 0÷60 °C. Avoid places subject to strong vibrations, corrosive gases, excessive dirt or humidity. The same recommendations apply to probes. Let air circulate by the cooling holes.

## 15. ELECTRICAL CONNECTIONS

The controller is provided with screw terminal blocks for wires having section not bigger than 2.5 mm<sup>2</sup>.

**Check power supply data before connection wires.**

**Keep the probe and the digital input wires separate from the power cable.**

Do not exceed the maximum rating current for each relay, check technical data and if the load is bigger, use filtered contactors.

Before connecting cables make sure the power supply complies with the instrument's requirements. Separate the input connection cables from the power supply cables, from the outputs and the power connections. **Do not exceed the maximum current allowed on each relay**, in case of heavier loads use a suitable external relay.

### 15.1 PROBES CONNECTION

**Pressure probe (4 - 20 mA):** respect the polarity. If using terminal ends be sure there are no bare parts which could cause short circuiting or introduce noise disturbance at high frequencies. To minimise the induced disturbances use shielded cables with the shield connected to earth.

**Temperature probe:** it is recommended to place the temperature probe away from direct air streams to correctly measure the temperature.

## 16. RS485 SERIAL LINK

All models can be integrated into the monitoring and alarm system XJ500 using the TTL serial port. They use the standard ModBus RTU protocol, so they can be fitted in a system integrator using this protocol.

**The controller has 2 serial addresses first one Ad1 for compressor section, second one Ad2 for fan section.**

**XJ500:** To completely monitor both sections the values of the 2 addresses have to be different.

If the Ad2 parameters have the same value the status of the fans is not monitored.

**X-WEB300/3000:** To completely monitor both sections the values of the 2 addresses have to be equal.

## 17. ALARM LIST

Usually alarm conditions are signalled by means of:

1. Activation of alarm output 0-12V
2. Buzzer activation
3. Message on proper display
4. Log of alarm: code and duration.

The table at paragraph 17.3

### 17.1 TYPES OF ALARMS AND SIGNALLING MANAGED

#### 17.1.1 **A12: Configuration alarm**

The following configuration parameters are checked after each modification.:

<b>OA1 + OA6</b>	Outputs 1- 6 configuration
<b>P2P</b>	Second probe presence.
<b>CtyP</b>	Compressor type
<b>dSEP</b>	Dynamic set point enabling
<b>AOP</b>	Probe for analog output
<b>tOP</b>	Probe for triac output

When these parameters are set in wrong way an alarm message is generated:

the label A12 is shown on the upper display, while the lower display signals what wrong setting has created the error:  
The following table contains the displayed messages:

Mess.	Errata	Corrige
<b>nLod</b>	Number of loads higher than loads available in the controller	<ul style="list-style-type: none"> <li>• Check number of oAi set as load, this number has to be lower of equal to the number of relay of the controller.</li> </ul>
<b>cStP</b>	Load (step) configuration error	<ul style="list-style-type: none"> <li>• A relay oA(i) has been set as compressor without a previous relay oA(i-1) has been set as compressor. El oA1 = StP</li> </ul>
<b>AOP2</b>	P2 probe not available for the 4÷20mA output	<ul style="list-style-type: none"> <li>• P2 probe not available P2P =no. Enable the probe setting: P2P =yES</li> <li>• The second probe P2 is used to control the temperature of the engine of screw compressors. Check CtyP and set it different from Scr.</li> </ul>
<b>dSP2</b>	P2 probe not available for the dynamic set point function	<ul style="list-style-type: none"> <li>• P2 probe not available P2P =no. Enable the probe setting: P2P =yES</li> <li>• The second probe P2 is used to control the temperature of the engine of screw compressors. Check CtyP and set it different from Scr.</li> </ul>
<b>FAP2</b>	P2 probe not available for fan regulation	<ul style="list-style-type: none"> <li>• P2 probe not available P2P =no. Enable the probe setting: P2P =yES</li> <li>• The second probe P2 is used to control the temperature of the engine of screw compressors. Check CtyP and set it different from Scr.</li> </ul>
<b>CSP2</b>	P2 probe not available for screw compressor	<ul style="list-style-type: none"> <li>• Check CtyP and set it different from Scr.</li> </ul>
<b>P2CF</b>	Wrong second probe configuration (El.: If Cty= Scr P2 ha to be PTC)	<ul style="list-style-type: none"> <li>• Set P2P = yES and PbC2 = PTC</li> </ul>

### 17.1.2 EA1+EA6: Compressors and fans safeties alarm.

#### Terminals

**WARNING: THESE TERMINALS REQUIRE A FREE OF VOLTAGE CONNECTION.**

The terminals (from 13 to 21) really used depends on the number of loads. The protections regarding the compressors and fans are connected to these inputs. If one of these protections is enabling (E.I. for lack of oil or overheating, etc.) the corresponding load is turn off.

#### Parameters

**ALIP:** It establishes if the input is activated by closing (ALIP=cL) or by opening (ALIP=oP) the terminals.

#### Actions

Every time one input is activated the corresponding output is turned off.

#### Recovery

Recovery depends on **ALMr** parameter:

With **ALMr = no** The instrument restart the standard operating mode when the input is disabled.

With **ALMr = yES** manual recover for the alarms of compressors and fans. Push the **DOWN** key for 3s.

### 17.1.3 P1, P2: probe failure alarm

It is generated by failure in the probe P1 or P2.

#### If both compressors and fans are managed by the instrument

**SPr:** number of steps engaged with faulty probe. (0÷# oAi = cPr or StP) It's used only if CtyP=Spo.

**PoPr:** capacity engaged with faulty probe (0÷255) It's used only if CtyP=dPo.

**FPr:** Number of fans engaged with faulty probe. (0÷# oAi = FAn)

#### If the second probe is used for dynamic set point

The function is disabled and only the standard set point is used.

#### If the second probe is used for analog output

The function is disabled, the value of the analog output is set in the SAo parameter.

#### Recovery

Automatic as soon as probe restarts working.

### 17.1.4 HA, LA, HA2, LA2High and low pressure (temperature) alarms

This alarm signals that the pressure (temperature) is out of limits established by parameters LAL and HAL for compressors and LAF –HAF for fans.

The **tAo** and **AFd** parameters set the delay between alarm condition and alarm signalling.

#### Action

The alarm is signalled with standard action. The outputs are unchanged.

## 17.2 ALARM MUTING

Press any buttons to silence the buzzer during an alarm condition.

Hold pressed for more than 3 seconds switch off the alarm relay during an alarm condition

### 17.3 ALARM CONDITIONS – SUMMARY TABLE

Code	Description	Cause	Action	Reset
P1	P1 probe failure alarm	Probe failure or out of range	The compressors are activated according to the SPr or PoPr parameters.	<b>Automatically</b> as soon as the probe restarts working.
P2	P2 probe failure alarm	Probe failure or out of range	The fans are activated according to the FPr parameters.	<b>Automatically</b> as soon as the probe restarts working.
EA1 EA2 EA3 EA4 EA5 EA6	Load safeties alarm	Safeties compressor/fan input activation. NOTE: with step compressors 1 input for each compressor has to be used.	the corresponding load is turned off. (with step compressors all relays referred to the input are disabled).	Recovery depends on <b>ALMr</b> parameter: With <b>ALMr = no</b> The instrument restart the standard operating mode when the input is disabled. With <b>ALMr = yES</b> manual recover for the alarms of compressors and fans. Push the <b>DOWN</b> key for 3s.
LA	Minimum pressure (temperature) alarm compressors section	Suction pressure or temperature lower than SET_C-LAL value	signalling only	<b>Automatically:</b> as soon as the pressure or temperature reaches the (Set_C-LAL+ differential) value. (differential = 0.3bar or 1°C)
LA2	Minimum pressure (temperature) alarm fans section	Condensing pressure or temperature lower than SET_F-LAL value	signalling only	<b>Automatically:</b> as soon as the pressure or temperature reaches the (Set_F-LAL+ differential) value. (differential = 0.3bar or 1°C)
HA	Maximum pressure (temperature) alarm compressors section	Suction pressure or temperature higher than SET_C+HAL value	signalling only	<b>Automatically:</b> as soon as the pressure or temperature reaches the (Set_C + HAL - differential) value. (differential = 0.3bar or 1°C)
HA2	Maximum pressure (temperature) alarm fans section	Condensing pressure or temperature higher than SET_F+HAL value	signalling only	<b>Automatically:</b> as soon as the pressure or temperature reaches the (Set_F + HAL - differential) value. (differential = 0.3bar or 1°C)
A14	Load maintenance alarm	A load has worked for the hour set in the SEr parameter	signalling only	<b>Manually:</b> reset the running hour of the compressor (see par. 8 <b>RUNNING HOURS OF LOADS</b> )

## 18. TECHNICAL FEATURES

**Housing:** Self extinguishing ABS.

**Case:** DIN modules 70x85 mm; depth 61mm

**Mounting :** DIN RAIL mounted in a omega (3) din rail

**Connections:** Screw terminal block  $\leq 2,5 \text{ mm}^2$  heat-resistant wiring;

**Power supply:** 120Vac  $\pm 10\%$ ,50-60Hz or 230Vac  $\pm 10\%$ ,50-60Hz or 24Vac

**Power absorption:** 5VA max.

**Display:** 3 digits red led and 4 digit orange led.

**Inputs:** 2 NTC probes, or 2 PTC probes and 2 4..20mA transducer.

**Digital inputs:** 6 free voltage

**Relay outputs:** 6 relay SPST 5(3)A, 250Vac

**Analog output:** 4-20mA optional

**Serial output :** TTL standard **Communication protocol:** ModBus – RTU

**Data storing:** on the non-volatile memory (EEPROM).

**Kind of action:** 1B; **Pollution grade:** normal; **Software class:** A.

**Operating temperature:** 0÷60 °C.; **Storage temperature:** -25÷60 °C.

**Relative humidity:** 20÷85% (no condensing)

**Measuring range: NTC probe:** -40÷110°C.

**Resolution:** 0,1 °C or 1°C; **Accuracy (ambient temp. 25°C):**  $\pm 0,7 \text{ }^\circ\text{C} \pm 1 \text{ digit}$

## 19. WIRING CONNECTIONS

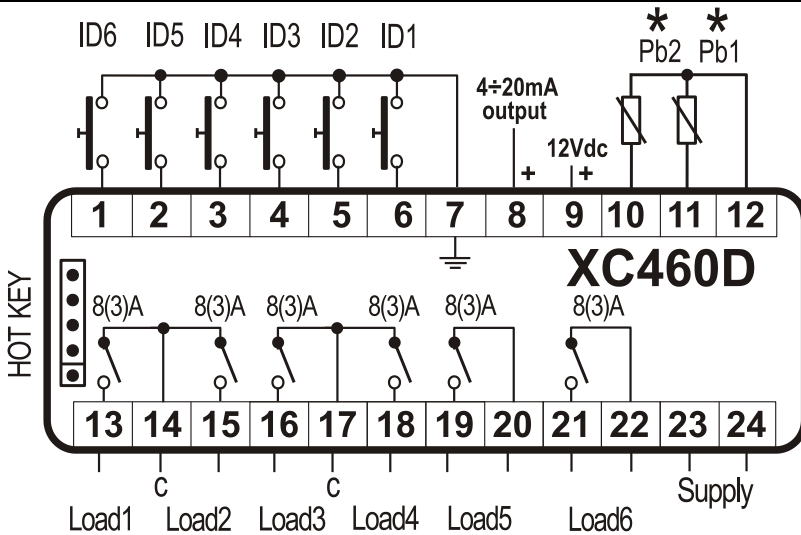

- \* PTC/NTC= 10 (In); 11(In); 12(gnd)
- \* 4÷20mA= 10 (In); 11(In); 12(gnd); 9(+)

**NOTE:** analog output is an option.

## 20. PARAMETERS – DEFAULT VALUES

<b>Fans parameters</b>
<b>Compressor parameters</b>
<b>Commons parameters</b>

Name	°C	°F	bar	PSI	Level	Description	Range
SEtc	-18,0	0	2,3	33	--	Set point for compressors	LSE ÷ HSE
SEtF	35,0	95	15,1	220	--	Set point for fans	LSF ÷ HSF
oA1	CPr	CPr	CPr	CPr	Pr2	Outputs 1 configuration	cPr / FAn / StP / ALr / LLn / nu
oA2	CPr	CPr	CPr	CPr	Pr2	Outputs 2 configuration	cPr / FAn / StP / ALr / LLn / nu
oA3	CPr	CPr	CPr	CPr	Pr2	Outputs 3 configuration	cPr / FAn / StP / ALr / LLn / nu
oA4	FAN	FAN	FAN	FAN	Pr2	Outputs 4 configuration	cPr / FAn / StP / ALr / LLn / nu
oA5	FAN	FAN	FAN	FAN	Pr2	Outputs 5 configuration	cPr / FAn / StP / ALr / LLn / nu
oA6	FAN	FAN	FAN	FAN	Pr2	Outputs 6 configuration	cPr / FAn / StP / ALr / LLn / nu
ctYP	SPo	SPo	SPo	SPo	Pr2	Compressor type	SPo / dPo / Scr
StP	CL	CL	CL	CL	Pr2	Valve outputs polarity	oP / cL
Pc1	20	20	20	20	Pr2	Power of compressor 1	0 ÷ 255
Pc2	20	20	20	20	Pr2	Power of compressor 2	0 ÷ 255
Pc3	20	20	20	20	Pr2	Power of compressor 3	0 ÷ 255
Pc4	20	20	20	20	Pr2	Power of compressor 4	0 ÷ 255
Pc5	20	20	20	20	Pr2	Power of compressor 5	0 ÷ 255
Pc6	20	20	20	20	Pr2	Power of compressor 6	0 ÷ 255
FtYP	404	404	404	404	Pr2	Freon Type	r22 / 404 / 507 / 134 / 717
rtY	db	db	db	db	Pr2	Type of regulation	db / Pb
CH	CL	CL	CL	CL	Pr2	Type of action	cL ÷ Ht
StY	yES	yES	yES	yES	Pr2	Compressor rotation	no / YES
rot	yES	yES	yES	yES	Pr2	Fans rotation	no / YES
Pbc	Cur	Cur	Cur	Cur	Pr2	Probe 1 setting	cur / Ptc / ntc
PA04	0,5	7	0,5	7	Pr2	Adjustment of read out for the Probe at 4mA	0.0 bar o 0 PSI ÷ PA20
PA20	12,0	174	12,0	174	Pr2	Adjustment of read out for the Probe at 20mA	PA04 ÷ 51.0 bar o 750 PSI
cAL	0	0	0	0	Pr2	Probe 1 calibration	-12.0 ÷ 12.0 °C o bar / -20 ÷ 20 °F o PSI
P2P	yES	yES	yES	yES	Pr2	Second probe presence	no / YES
Pbc2	Cur	Cur	Cur	Cur	Pr2	Probe 2 setting	cur / Ptc / ntc
FA04	1	14	1	14	Pr2	Adjustment of read out for the Probe at 4mA	0.0 bar o 0 PSI ÷ FA20
FA20	31	450	31	450	Pr2	Adjustment of read out for the Probe at 20mA	FA04 ÷ 51.0 bar o 750 PSI
FcAL	0	0	0	0	Pr2	Probe 2 calibration	-12.0 ÷ 12.0 °C o bar / -20 ÷ 20 °F o PSI
ALiP	CL	CL	CL	CL	Pr2	Alarm input for compressors and fans polarity	oP / cL
ALMr	no	no	no	no	Pr2	Manual reset of alarms for compressors and fans	no / YES
dEu	°C	°F	bar	PSI	Pr2	Default measurement unit for displaying	bar / °C / PSI / °F
rES	dE	in	dE	in	Pr2	Resolution for °C and bar	in / dE
dSP2	P1	P1	P1	P1	Pr2	Default visualisation of lower display	nu – P1 – P2 – SEt1 – SEt2

Name	°C	°F	bar	PSI	Level	Description	Range
dEU2	PrS	PrS	PrS	PrS	Pr2	Lower display probe format	PrS ÷ tPr
rELP	rEL	rEL	rEL	rEL	Pr2	Pressure displaying	rEL / AbS
Pbd	4	8	0.5	7	Pr2	Proportional band or neutral zone width	> 0 ÷ 10.0 bar / 30.0 °C / 80 PSI / 50 °F
onon	5	5	5	5	Pr2	Minimum time between 2 following switching ON of the same compressor	0 ÷ 255 min.
oFon	2	2	2	2	Pr2	Minimum time between the switching off of a compressor and the following switching on	0 ÷ 255 min.
don	0,3	0,3	0,3	0,3	Pr2	Time delay between the insertion of two different compressors	0 ÷ 99.5 min. ( res. 10 sec. )
doF	0,1	0,1	0,1	0,1	Pr2	Time delay between switching off of two different compressors	0 ÷ 99.5 min. (res.10 sec. )
donF	0,3	0,3	0,3	0,3	Pr2	Minimum time a stage stays switched ON	0 ÷ 99.5 min. (res.10 sec. )
MAon	0	0	0	0	Pr2	Maximum time for compressor ON	0 ÷ 24 h
FdLY	no	no	no	no	Pr2	"don" delay enabled also for the first call	no / YES
FdLF	no	no	no	no	Pr2	"doF" delay enabled also for the first switching off	no / YES
odo	20	20	20	20	Pr2	Regulation delay on start-up	0 ÷ 255 sec.
LSE	-40	-40	0,3	5	Pr2	Minimum set point for compressors	PA04 ÷ HSE
HSE	10	50	7,2	100	Pr2	Maximum set point for compressors	LSE ÷ PA20
Pb	4	8	2.0	24	Pr2	Proportional band or neutral zone width for fans	0.1÷10.0 bar / 30.0°C /80 PSI/ 50°F
Fon	15	15	15	15	Pr2	Time delay between the insertion of two different fans	0 ÷ 255 sec.
FoF	5	5	5	5	Pr2	Time delay between switching off of two different fans	0 ÷ 255 sec.
LSF	10	50	7,2	100	Pr2	Lower set for fans	PA04 ÷ HSF
HSF	60	140	27,8	404	Pr2	Higher set for fans	LSF ÷ PA20
PAo	30	30	30	30	Pr2	Alarm probe exclusion at power on	0 ÷ 255 min.
LAL	15,0	30	1,5	21	Pr1	Low pressure (temperature) alarm – compressor section	> 0 ÷ 30.0 bar / 100.0 °C / 430 PSI / 200 °F
HAL	20,0	40	2,5	46	Pr1	High pressure (temperature) alarm– compressor section	> 0 ÷ 30.0 bar / 100.0 °C / 430 PSI / 200 °F
tAo	15	15	15	15	Pr1	Low and High pressure (temperature) alarms delay– compressor section	0 ÷ 255 min.
SEr	999	999	999	999	Pr2	Service request	( 0 = disable ) 1 ÷ 999; res 10h
SPr	2	2	2	2	Pr2	Number of steps engaged with faulty probe	0 ÷ # compressors
PoPr	50	50	50	50	Pr2	Capacity engaged with faulty probe	0 ÷ 100 %
LAF	20	40	6,7	96	Pr1	Low pressure alarm – fans section	> 0 ÷ 30.0 bar / 100.0 °C / 430 PSI / 200 °F
HAF	20	40	9,8	141	Pr1	High pressure alarm – fans section	> 0 ÷ 30.0 bar / 100.0 °C / 430 PSI / 200 °F
AFd	15	15	15	15	Pr1	Low and High pressure alarms delay – fans section	0 ÷ 255 min.
FPr	2	2	2	2	Pr2	Number of fans engaged with faulty probe	0 ÷ # fans
dSEP	no	no	no	no	Pr2	Dynamic set point enabling	no / YES
dSES	100	100	100	100	Pr2	External temperature set point to start dynamic regulation	0.0 ÷ 150.0 °C / 32 ÷ 302 °F

Name	°C	°F	bar	PSI	Level	Description	Range
dSEb	10	10	10	10	Pr2	External band width for dynamic set point	-50.0 ÷ 50.0 °C / -90 ÷ 90 °F
dSEd	0	0	0	0	Pr2	Set point differential for dynamic set point	- + 20.0 bar / - + 50.0 °C / - + 300 PSI / - + 90 °F
LAO*	0	0	0	0	Pr2	Start of scale for analog output	AOC=Pb : 0.0÷51.0(BAR) - 50.0÷150.0(°C) 0÷750(PSI) - 58÷302(°F);
UAO*	1	1	1	1	Pr2	End of scale for analog output	AOC=Pb : 0.0÷51.0(BAR) - 50.0÷150.0(°C) 0÷750(PSI) - 58÷302(°F)
AOM*	4	4	4	4	Pr2	Minimum value for analog output	4 ÷ 20
SAO*	4	4	4	4	Pr2	Percentage of analog output in case of probe failure	0 ÷ 100 (%)
tbA	yES	yES	yES	yES	Pr2	Alarm relay silencing	no / YES
OAP	cL	cL	cL	cL	Pr2	Alarm relay output polarity	cL ÷ oP
oFF	no	no	no	no	Pr2	Switching ON/OFF enabling from keyboard	no / YES
Ad1	1	1	1	1	Pr2	Compressors address	1 ÷ 247
Ad2	1	1	1	1	Pr2	Fans address	1 ÷ 247
rEL	-	-	-	-	Pr1	Software release	readable only
Ptb	-	-	-	-	Pr1	Parameter table code	readable only
Pr2					Pr1	Password protected menu	readable only

\* Analog output is optional

**Dixell**



Dixell S.r.l. - Z.I. Via dell'Industria, 27 - 32010 Pieve d'Alpago (BL) ITALY  
Tel. +39.0437.9833 r.a. - Fax +39.0437.989313 - EmersonClimate.com/Dixell - dixell@emerson.com