

No.	Name	Note	No.	Name	Note
1	Angle valve	1/4"Flare	16	Angle valve	1/4"Flare
2	Discharge flange	4"	17	Refrigerant service valve	1/4"Flare
3	Solenoid valve	50%(NC)	18	Solenoid valve	Stepless(NC or NO), option
4	Solenoid valve	75%(NC)	19	Liquid injection connector	5/8"Flare
5	Solenoid valve	35%(NC)	20	Suction flange	5"
6	Liquid(oil or refrigerant) injection connector	3/8"Flare	21	Cable box	Standard
7	Capillary		22	Service flange	
8	Check valve	4"	23	Oil drain valve	
9	Oil flow sight glass		24	Oil level switch	
10	Oil heater	150W/300W	25	Discharge temp. sensor	110°C
11	Oil filter cartridge		26	Safety Valve	1"NPT,option
12	Oil pressure differential switch	Connector, option	27	Economizer port	1 1/8", solder
13	Oil cooler connector(out)	3/4"Flare, option	28	Oil level sight glass	
14	Stop pin	option	29	Over flow port	option
15	Oil cooler connector(in)	3/4"Flare, option			

*All stop valves are optional.

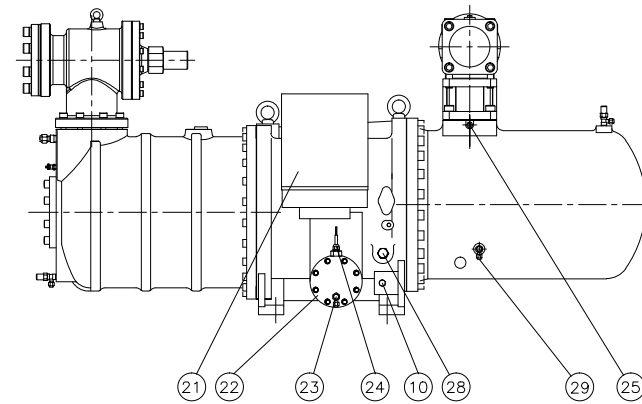
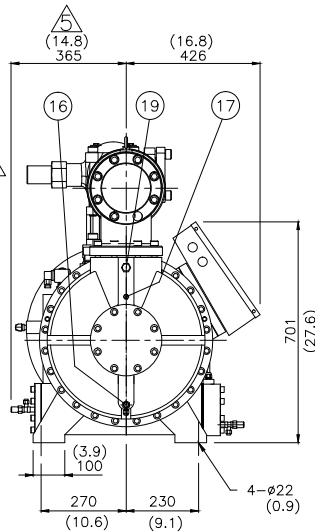
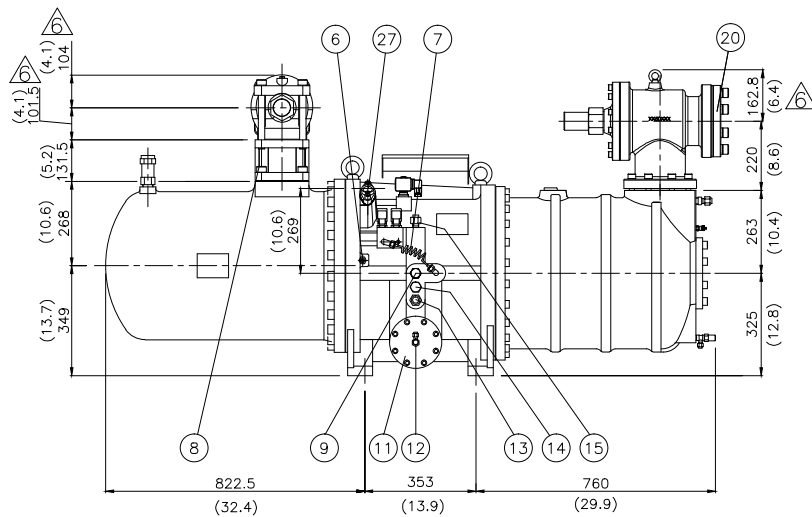

UNIT:
SI: mm Imperial: (in)

Item	Date	Modification
△6	2014.08.21	Dimension correction
△5	2012.11.08	Dimension correction
△4	2012.04.19	Delete1.Connector 2.Oil temp. sensor

Model	RC2-710B
Name	Compressor outline
	HANBELL Ver. 06