

EA-340AC8-C01
Evaporator
Technical Specifications

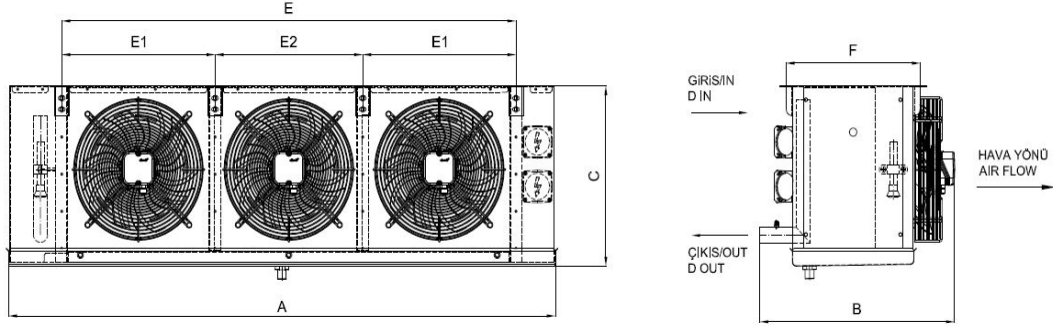

Dimensions

A (mm) :	1957	B (mm) :	586	C (mm) :	605	F (mm) :	395	E1 (mm) :	568
E2 (mm) :	550	E (mm) :	1685	#REF! :	Ø22	#REF! :	Ø35	W (kg) :	81

Capacity Information

Capacity	9,173.00 Watt	Heat Transfer Surface	32,6 m ²
Average Room Temperature	-18.00 °C	Tube Volume	12,7 dm ³
Evaporasyon Sıcaklığı	-25.00 °C	Fin Spacing	8 mm
ΔT	7 K	Test Pressure / Max. Operating Pressure	35 / 25 bar
Refrigerant	R404A	Energy Efficiency Class	E
Altitude	0 m	Air Throw Distance	13.5 m

Evaporator Fan Data

Air Flow	10445 m ³ /h	Fan Protection / Isolation Class	IP44 / CLASS F
Number of Fans / Fan Diameter / Fan Cycle	3 / 400 mm / 1430 rpm	Operating Temperature Range	-40/60
Total Fan Power / Current	0.48 kW / 2.19 A	Sound Power Level (LWA)	85 dBA
Fan Voltage / Fan Frequency / Fan Phase	230 Volt / 50 Hz / 1 Ph	Sound Pressure Level (LPA)	63 dBA @ 3 m
fan rankings	1x3		

Configuration

Configuration Name

Code

Cassette Type	RAL 9016 painted Galvanized Sheet	-
Defrost Type	E2 Defrost (Coil + Tray)	4x1760+1x1760 Watt

Notes.

- Capacity correction calculation for altitude is according to related Eurovent Standard.
- Sound pressure calculation standard: EN13487
- Energy Efficiency Class calculation standards: EN328 and Related Eurovent Standard. Standard Conditions: SC2,R404A
- All of the technical information is subject to change without notice.
- All of the performance and technical data according to default configuration.

Karyer Isı Transfer Sanayi ve Ticaret A.Ş.

Topçular Mah. Tikveşli Yolu No:8 34140 Topçular - Eyüp / İstanbul Tel: 0 (212) 567 55 09 Pbx

Faks: 0 (212) 576 23 45

E-mail: info@karyergroup.com Web: http://www.karyergroup.com/