

EA-435AE8-C01
Evaporator
Technical Specifications

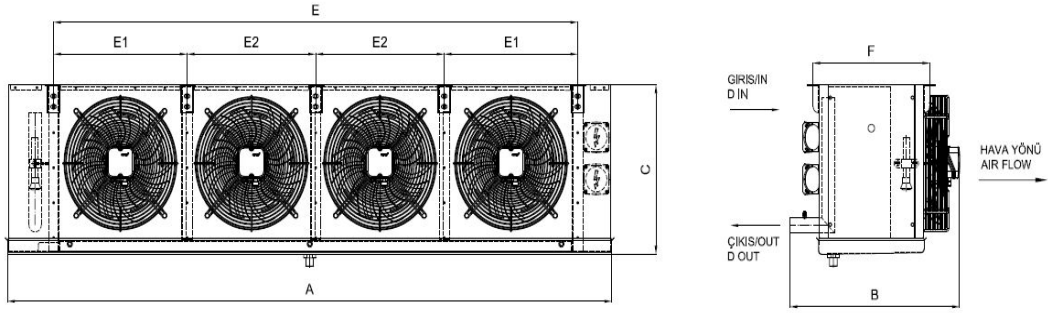

Dimensions

A (mm) :	2307	B (mm) :	573	C (mm) :	525	F (mm) :	395	E1 (mm) :	518
E2 (mm) :	500	E (mm) :	2035	#REF! :	Ø19	#REF! :	Ø35	W (kg) :	100

Capacity Information

Capacity	12,631.00 Watt	Heat Transfer Surface	50,8 m ²
Average Room Temperature	-18.00 °C	Tube Volume	19,2 dm ³
Evaporasyon Sıcaklığı	-25.00 °C	Fin Spacing	8 mm
ΔT	7 K	Test Pressure / Max. Operating Pressure	35 /25 bar
Refrigerant	R404A	Energy Efficiency Class	E
Altitude	0 m	Air Throw Distance	11.7 m

Evaporator Fan Data

Air Flow	9679 m ³ /h	Fan Protection / Isolation Class	IP44 / CLASS F
Number of Fans / Fan Diameter / Fan Cycle	4 / 350 mm / 1340 rpm	Operating Temperature Range	-25/65
Total Fan Power / Current	0.66 kW / 2.92 A	Sound Power Level (LWA)	76 dBA
Fan Voltage / Fan Frequency / Fan Phase	230 Volt / 50 Hz / 1 Ph	Sound Pressure Level (LPA)	54 dBA @ 3 m
fan rankings	1x4		

Configuration

Configuration Name

Code

Cassette Type	RAL 9016 painted Galvanized Sheet	-
Defrost Type	E2 Defrost (Coil + Tray)	4x2155+1x2160 Watt

Notes.

- Capacity correction calculation for altitude is according to related Eurovent Standard.
- Sound pressure calculation standard: EN13487
- Energy Efficiency Class calculation standards: EN328 and Related Eurovent Standard. Standard Conditions: SC2,R404A
- All of the technical information is subject to change without notice.
- All of the performance and technical data according to default configuration.

Karyer Isı Transfer Sanayi ve Ticaret A.Ş.

Topçular Mah. Tikveşli Yolu No:8 34140 Topçular - Eyüp / İstanbul Tel: 0 (212) 567 55 09 Pbx
Faks: 0 (212) 576 23 45
E-mail: info@karyergroup.com Web: http://www.karyergroup.com/