

## EA-450AE8-C02 Δ

### Evaporator Technical Specifications

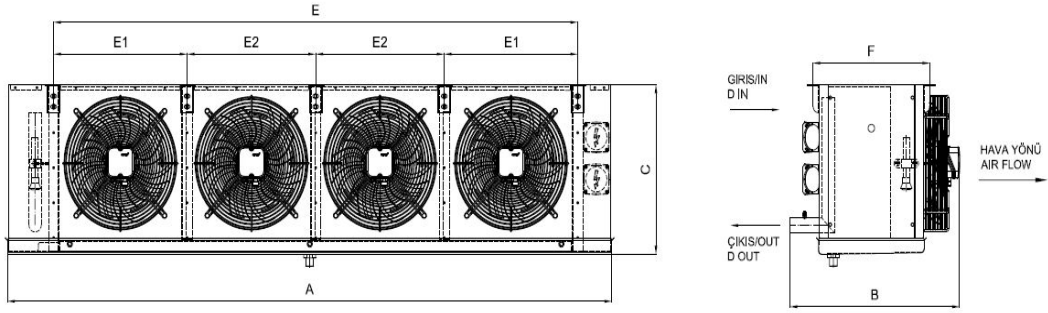

#### Dimensions

A (mm) :	3707	B (mm) :	640	C (mm) :	715	F (mm) :	560	E1 (mm) :	868
E2 (mm) :	850	E (mm) :	3435	#REF! :	Ø42	#REF! :	Ø54	W (kg) :	212

#### Capacity Information

Capacity	32,838.00 Watt	Heat Transfer Surface	115,2 m <sup>2</sup>
Average Room Temperature	-18.00 °C	Tube Volume	44,7 dm <sup>3</sup>
Evaporasyon Sıcaklığı	-25.00 °C	Fin Spacing	8 mm
ΔT	7 K	Test Pressure / Max. Operating Pressure	35 /25 bar
Refrigerant	R404A	Energy Efficiency Class	E
Altitude	0 m	Air Throw Distance	22.9 m

#### Evaporator Fan Data

Air Flow	29633 m <sup>3</sup> /h	Fan Protection / Isolation Class	IP54 / CLASS F
Number of Fans / Fan Diameter / Fan Cycle	4 / 500 mm / 1340 rpm	Operating Temperature Range	-40/70
Total Fan Power / Current	3.36 kW / 5.8 A	Sound Power Level (LWA)	86 dBA
Fan Voltage / Fan Frequency / Fan Phase	400 Volt / 50 Hz / 3 Ph	Sound Pressure Level (LPA)	64 dBA @ 3 m
fan rankings	1x4		

#### Configuration

#### Configuration Name

#### Code

Cassette Type	RAL 9016 painted Galvanized Sheet	-
Defrost Type	E2 Defrost (Coil + Tray)	6x3500+2x3500 Watt

#### Notes.

- Capacity correction calculation for altitude is according to related Eurovent Standard.
- Sound pressure calculation standard: EN13487
- Energy Efficiency Class calculation standards: EN328 and Related Eurovent Standard. Standard Conditions: SC2,R404A
- All of the technical information is subject to change without notice.
- All of the performance and technical data according to default configuration.

#### Karyer Isı Transfer Sanayi ve Ticaret A.Ş.

Topçular Mah. Tikveşli Yolu No:8 34140 Topçular - Eyüp / İstanbul Tel: 0 (212) 567 55 09 Pbx

Faks: 0 (212) 576 23 45

E-mail: info@karyergroup.com Web: http://www.karyergroup.com/