

KA-t-2x191KB1-B06 Δ

Condenser Technical Specifications

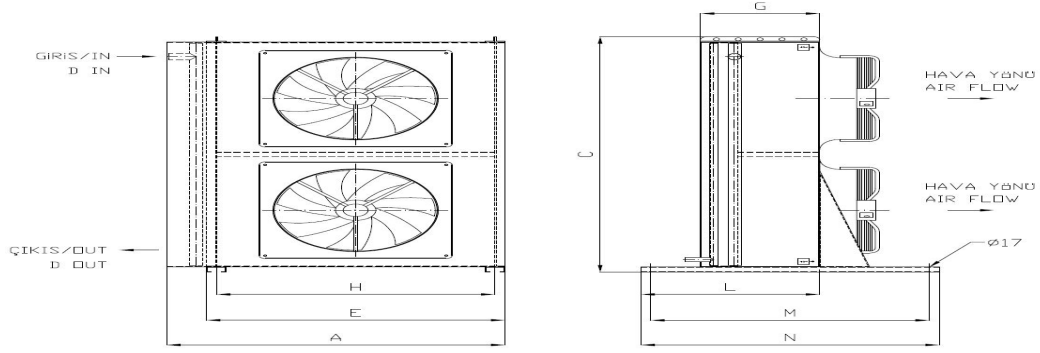

Dimensions

A (mm) :	1700	C (mm) :	2310	G (mm) :	450	E (mm) :	1500	H (mm) :	1400
L (mm) :	650	#REF! :	Ø42	#REF! :	Ø35	M (mm) :	1155	N (mm) :	1255
W (kg) :	347								

Capacity Information

Capacity	151,080.00 Watt	Heat Transfer Surface	214,3 m ²
Ambient Temperature	25.00 °C	Tube Volume	28,2 dm ³
Condensation Temperature	40.00 °C	Fin Spacing	2.1 mm
ΔT	15 K	Test Pressure / Max. Operating Pressure	35 /27 bar
Refrigerant	R404A	Energy Efficiency Class	E
Altitude	0 m		

Evaporator Fan Data

Air Flow	49370 m ³ /h	Fan Protection / Isolation Class	IP54 / CLASS F
Number of Fans / Fan Diameter / Fan Cycle	2 / 910 mm / 840 rpm	Operating Temperature Range	-40/70
Total Fan Power / Current	5.6 kW / 10.8 A	Sound Power Level (LWA)	93 dBA
Fan Voltage / Fan Frequency / Fan Phase	400 Volt / 50 Hz / 3 Ph	Sound Pressure Level (LPA)	81 dBA @ 1 m
fan rankings	2x1		

Configuration

Configuration Name

Code

Cassette Type	RAL 9016 painted Galvanized Sheet	-
---------------	-----------------------------------	---

Notes.

- Capacity correction calculation for altitude is according to related Eurovent Standard.
- Sound pressure calculation standard: EN13487
- Energy Efficiency Class calculation standards: EN327 and Related Eurovent Standard. Standard Conditions: Tair inlet=25 °C, Tcond.= 40 °C, R404A, P= 1,01325 bar.
- All of the technical information is subject to change without notice.
- All of the performance and technical data according to default configuration.

Karyer Isı Transfer Sanayi ve Ticaret A.Ş.

Topçular Mah. Tikveşli Yolu No:8 34140 Topçular - Eyüp / İstanbul Tel: 0 (212) 567 55 09 Pbx
Faks: 0 (212) 576 23 45
E-mail: info@karyergroup.com Web: http://www.karyergroup.com/