

SPECIFICATIONS for LANHAI HERMETIC COMPRESSOR

R22

QXR-25E

1PH, 220V – 50Hz

Application Range

Compressor Cooling	Natural	
Eva. Temp. Range	-10°C ~ 12°C	14°F ~ 54°F
Condensing Temp.	65°C max.	149°F max.
Return Gas Temp.	35°C max.	95°F max.
Discharge gas Temp.	115°C max.	239°F max.
Motor Wire Temp.	130°C max.	266°F max.

Rated Performance

Capacity	14348 Btu/4220 W
Motor Input	1410 W
Current	6.6 A
COP	2.993 W/W

Compressor Data

Design	Rolling Piston Typed Rotary
Displacement	25.4 cc/rev
Oil / Oil Charge	SUNISO 4GSI / 480ml
Weight	15.7 Kg

Motor Data

Motor Type	2 Pole Induction (PSC)
Rated Output	1284 W
Winding Resistance (at 25°C)	Main 1.910 Ω Sub 4.680 Ω
Voltage Range	198 V to 242 V
Locked Rotor Amps.	32.0 A

Electrical Components

Running Capacitor	35 μF 450 VAC
Overload Protector	External Type B300-150

Capacity Test Conditions

Evaporating Temp.	7.2°C	45°F
Condensing Temp.	54.4°C	130°F
Return Gas Temp.	35.0°C	95°F
Liquid Temp.	46.1°C	115°F
Ambient Temp.	35.0°C	95°F

Standard Dimensions(MM)

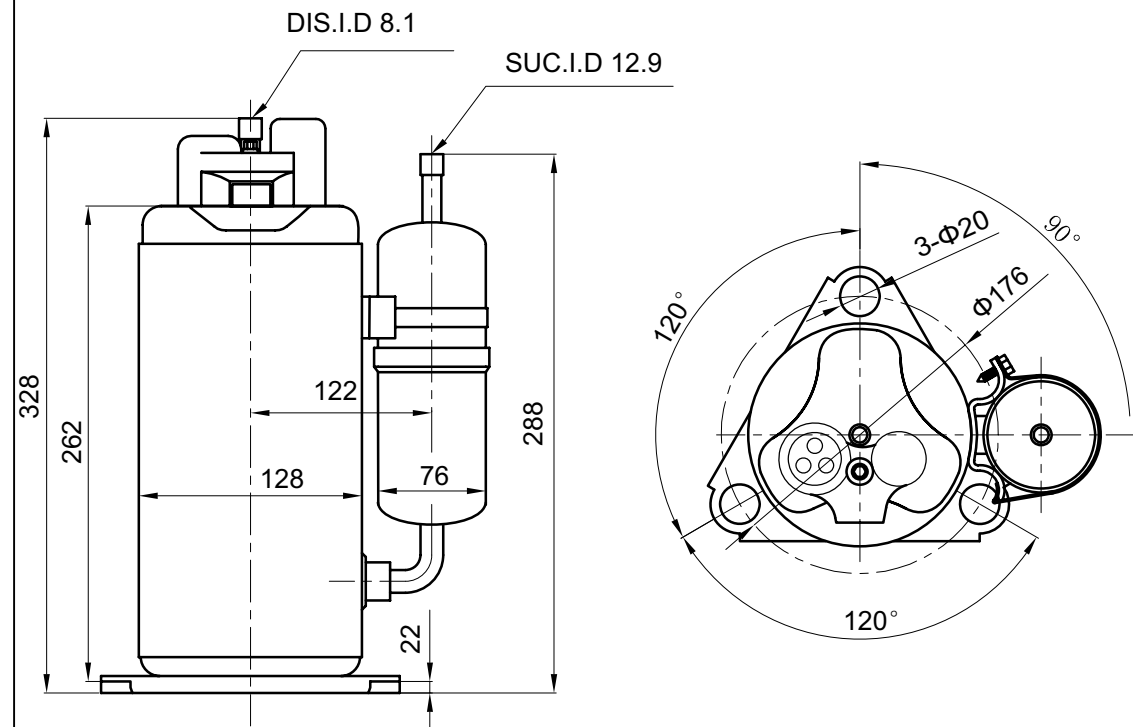

Compressor Mounting

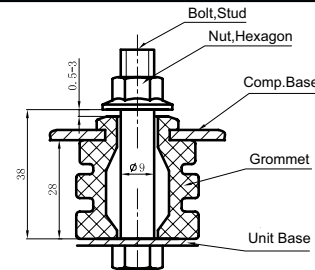

Wiring Diagram

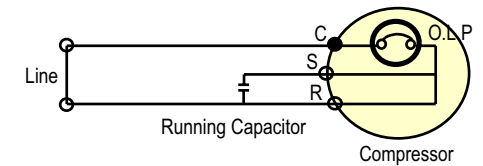

※ C.S.R mark is embossed on a Cover Terminal